

AKLF-20W

GaAs + GaN Technology

Low cost 20W low Ku-Band BUCs



FEATURES:

- Low Cost Solution
- Extreme Efficiency, Stability, Reliability and Performance
- Hyper-Light Package, Only 1.5lbs
- Super Low Power Consumption (70W* @20W)
- Fan-less Design
- Exceeds ALL IESS-308/309 Phase Noise Standards
- 3 Year Warranty



DESIGN OVERVIEW:

The low cost "FANLESS BRICK" series low Ku-Band BUCs are the next generation of the World's Smallest feed-horn & boom-arm mountable BUCs in the industry, weighing only 1.5lbs and handling output power of 20W at the Ku-Band frequencies. We've picked the most mature, reliable and proven to be highly efficient amplifiers with internal overdrive protection. Each unit is vigorously tested at our California facility according to our ATP (Acceptance Testing Procedure).

PERFORMANCE SPECIFICATIONS

Operating RF Frequency	AKLF 12.75 - 13.25 GHz
Operating IF frequency	950 - 1450 MHz
Local Oscillator	11.80 GHz
Rated Output Power PSAT	20W 43.0 dBm
Linear Power SR @ -26dBc PLIN	16W 42.0 dBm
IMD3 (two tones) 3dB Back Off	-25 dBc max. 2 signal 5MHz apart at P-LINEAR
Spectral Regrowth at PLINEAR (QPSK at 1.5x and OQPSK at 1.0x symbol rate offset with 2dB back-off from rated power)	-30 dBc

SPURIOUS & PHASE NOISE

In-Band/Out-band Spurious	-60dBc max.	
Group Delay	Ripple 1 nsec point to point max.	
AM/PM Conversion	1.0°/dB max. at 3 dB output backoff	
Noise Power Density (TX)	-85dBm/Hz	
Noise Power Density (RX)	-155dBm/Hz (10.95 - 12.75 GHz)	
Phase Noise (Up Converter) (Ext. Ref.)	-55 dBc/Hz @ 10 Hz	-115dBc/Hz
	-65 dBc/Hz @ 100 Hz	-135dBc/Hz
	-75 dBc/Hz @ 1 kHz	-150dBc/Hz
	-85 dBc/Hz @ 10 kHz	-155dBc/Hz
	-95 dBc/Hz @ 100 kHz	-160dBc/Hz

POWER CONSUMPTION

20W 43.0 dBm PSAT	70W
16W 42.0 dBm PLIN	60W

COMPLIANCE INFORMATION

MIL - STD - 188/164C	MIL - STD - 461	ROHS, REACH, WEEE
MIL - STD - 810E	DO - 160 G	

PROTECTION

VOLTAGE	OVERTEMP	CURRENT
SMART ALARMS IN THE M&C	MICROPHONIC	

ENVIRONMENT SPECIFICATIONS

Environmental MIL-STD	Compliant with MIL-STD810E
Vibration MIL-STD	MIL-STD810F, Method 514.5 C-2 Transport
Operating Temperature Range	- 40° C to + 70°C
Storage Temperature Range	- 60°C to + 85°C
Humidity	100% Condensing, IP67
Shock	20 g peak, 11 msec, 1/2 sine
Altitude	50,000ft, 15,240m

M&C INTERFACE

Advanced Monitor & Control	RS232 (RS48, Ethernet Web Page Based, Telnet)*
ALARMS	PLL LOCK, HPA, MUTE, TX
Stealth PLin Operation Mode	LED Shut-Off Silenced fan

PART NUMBERING SYSTEM

- S - Slim Size Series
- F - Fan-less Series
- G - Fan-less and Slim Series
- KU - Universal Ku-Band 13.75 - 14.50 GHz
- KS - Standard Ku-Band 14.0 - 14.50 GHz
- KL - Low Ku-Band 12.75 - 13.25 GHz
- KD - Dual Ku-Band 13.75 - 14.50 GHz | 14.0 - 14.50 GHz
- 8 | 10 | 12 | 16 | 20 - Rated Power in Watts
- N | F - 50 Ohm or 75 Ohm IF Input Connector Type
- M1 - M&C Option RS232 Only
- M2 * - RS232/485, Ethernet, SNMP, Telnet
- R - 10 MHz Ref. Auto Sense | Internal Reference
- U - Universal Mounting Bracket

* Advanced M&C option coming soon

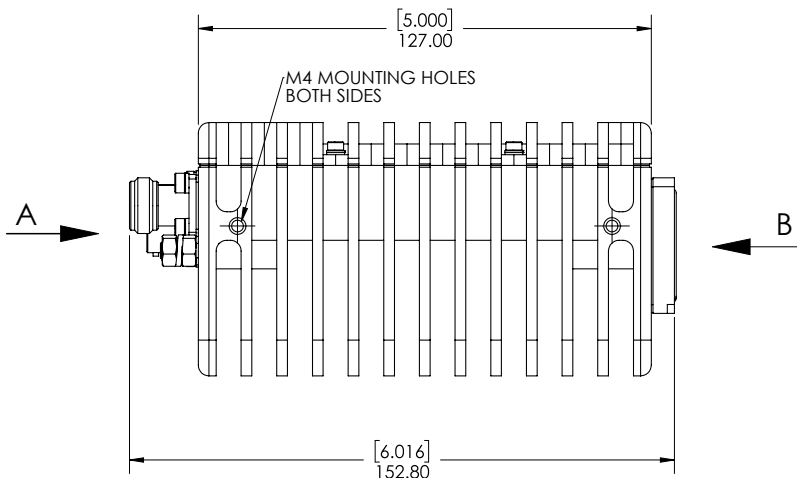

INPUT|OUTPUT INTERFACE

IF Connector	N-type (50 Ohm) F-type (75 Ohm)
Universal Prime Power via IF	+ 18 - 55 VDC
Output Interface	WR75 Sealed & Grooved

GAIN

Gain (Temperature Compensated)	55 dB(min) 60 dB(typ.)
TX Gain Flatness	± 0.75 dB max. over 40 MHz
TX Gain variation 50MHz	± 0.5 dB
TX Gain variation 500MHz	± 1.5 dB

MECHANICAL SPECIFICATIONS

Dimensions	6.1" x 4.7" x 2.8" (153 × 120 × 71mm)
Weight	1.5lbs (0.68kg)

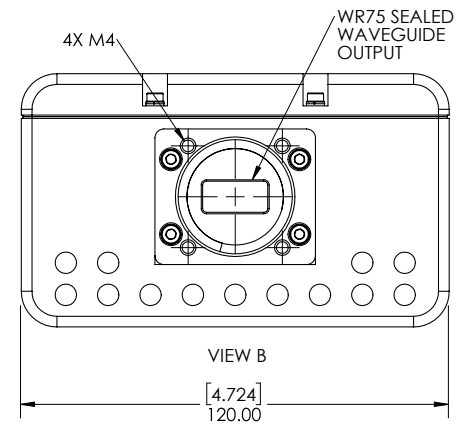
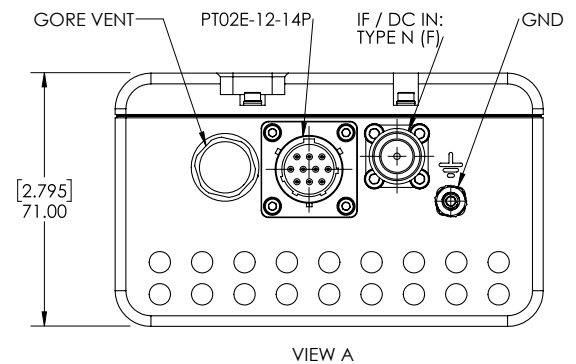

Visit Product Page